



## GLL Series

---

### Limit Switches

#### DESCRIPTION

Honeywell's new GLL Series limit switch is the newest addition to the OEM set of miniature limit switches. It combines and enhances the existing GLS, SZL-VL, and EVN switches into one common family, competitively priced for OEM applications.

The double insulated compact housing conforms to EN500047 and makes GLL switches often ideal for mounting where space is at a premium. These products feature direct opening normally closed circuits.

The GLL Series is available in a variety of actuator styles required for OEM applications. Designed to the IEC electrical standard, GLL is suitable for world-wide use and also meets globally accepted mounting standards.

The GLL Series provides a cost-effective solution for OEM high volume applications and enables manufacturers to be competitive in today's demanding business environment.

#### FEATURES

---

- Double break, direct-opening snap action contacts conform to IEC 60947-5-1-3 
- EN50047 mounting
- 20 mm and 1/2" NPT conduit options
- Galvanically isolated contacts
- Double insulated plastic housing
- Contact block integral to switch housing
- Hinge cover for easy wiring access
- 50 mm rubber rollers ideal for elevator applications
- Sealing IP65, NEMA 1, 12, 13
- c-UL-US, CE, CCC



#### POTENTIAL APPLICATIONS

---

- Elevators
- Escalators
- Aerial/Platform lifts
- Industrial doors
- Packaging equipment

# GLL Series

## SPECIFICATION DATA

	 GLLA01B, GLLC01B	 GLLA01C, GLLC01C	 GLLA01A1B, GLLC01A1B
<b>Actuator</b>	Top plunger	Top roller plunger	Side rotary – 25 mm fixed length with metal roller (17,0 mm dia. x 7,0 mm wide)
<b>Operating force (O.F.)</b>	9,8 N max. [2.22 lbs]	9,8 N max. [2.22 lbs]	12,0 N-cm [1.062 lb-in]
<b>Release force (R.F.)</b>	1,5 N [0.34 lbs]	1,5 N [0.34 lbs]	2,0 N-cm [0.177 lb-in]
<b>Pretravel (P.T.)</b>	2,8 mm max. [0.11 in]	2,8 mm max. [0.11 in]	30° max.
<b>Overtravel (O.T.)</b>	3,0 mm min. [0.12 in min.]	3,0 mm min. [0.12 in min.]	40° min.
<b>Differential travel (D.T.)</b>	1,5 mm max. [0.06 in max.]	1,5 mm max. [0.06 in max.]	18° max.
<b>Operating position (O.P)</b>	18 mm ± 0,5 mm [0.71 in ± 0.02 in]	28,7 mm ± 0,5 mm [1.13 in ± 0.02 in]	30°
<b>Circuitry</b>	1 NO 1 NC direct opening snap action		
<b>Ampere rating</b>	10 A (Thermal)		
<b>Supply voltage</b>	300 Vac and 250 Vdc max.		
<b>Housing material</b>	Plastic		
<b>Termination type</b>	12,7 mm [0.5 in] conduit; 20 mm [0.79 in] conduit		
<b>Housing type</b>	EN 50047		
<b>Shock</b>	50 g per PEC 68-2-27c (w/o actuator)		
<b>Vibration</b>	10 g per IEC 68-2-6 (w/o actuator)		
<b>Sealing</b>	IP65, NEMA 1, 12, 13		
<b>Approvals</b>	c-UL-US, CE, CCC		
<b>Mechanical life</b>	5 million operations		
<b>Operating temperature range</b>	-10 °C to 80 °C [14 °F to 176 °F]		

# Limit Switches

## SPECIFICATION DATA

			
	<b>GLLA01A2B, GLLC01A2B</b>	<b>GLLA01A1Y, GLLC01A1Y</b>	<b>GLLA01A2Y, GLLC01A2Y</b>
<b>Actuator</b>	Side rotary – 20 mm to 65 mm adjustable length lever with metal roller (17,0 mm dia. x 7,0 mm wide)	Side rotary – 31,5 mm fixed length lever with 50 mm rubber roller (50,0 mm dia. x 10,0 mm wide)	Side rotary – 20 mm to 65 mm adjustable length lever with 50 mm rubber roller (50,0 mm dia. x 10,0 mm wide)
<b>Operating force (O.F.)</b>	12,0 N-cm [1.062 lb-in]	12,0 N-cm [1.062 lb-in]	12,0 N-cm [1.062 lb-in]
<b>Release force (R.F.)</b>	2,0 N-cm [0.177 lb-in]	2,0 N-cm [0.177 lb-in]	2,0 N-cm [0.177 lb-in]
<b>Pretravel (P.T.)</b>	30° max.	30° max.	30° max.
<b>Overtravel (O.T.)</b>	40° min.	40° min.	40° min.
<b>Differential travel (D.T.)</b>	18° max.	18° max.	18° max.
<b>Operating position (O.P)</b>	30°	30°	30°
<b>Circuitry</b>	1 NO 1 NC direct opening snap action		
<b>Ampere rating</b>	10 A (Thermal)		
<b>Supply voltage</b>	300 Vac and 250 Vdc max.		
<b>Housing material</b>	Plastic		
<b>Termination type</b>	12,7 mm [0.5 in] conduit; 20 mm [0.79 in] conduit		
<b>Housing type</b>	EN 50047		
<b>Shock</b>	50 g per PEC 68-2-27c (w/o actuator)		
<b>Vibration</b>	10 g per IEC 68-2-6 (w/o actuator)		
<b>Sealing</b>	IP65, NEMA 1, 12, 13		
<b>Approvals</b>	c-UL-US, CE, CCC		
<b>Mechanical life</b>	5 million operations		
<b>Operating temperature range</b>	-10 °C to 80 °C [14 °F to 176 °F]		

# GLL Series

## DIMENSIONS [mm]

**GLLA01B, GLLC01B**

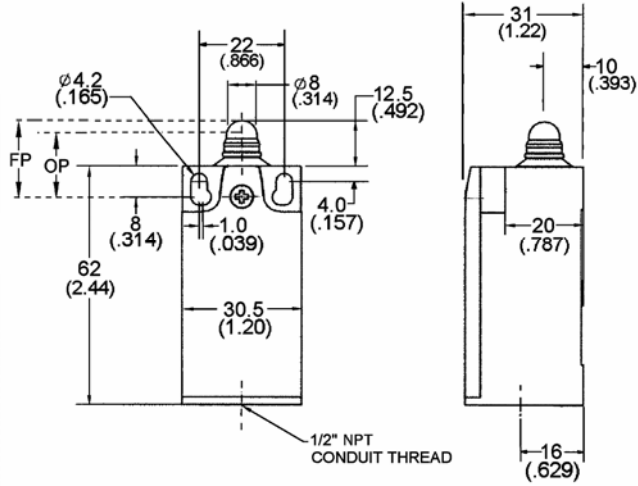

**GLLA01C, GLLC01C**

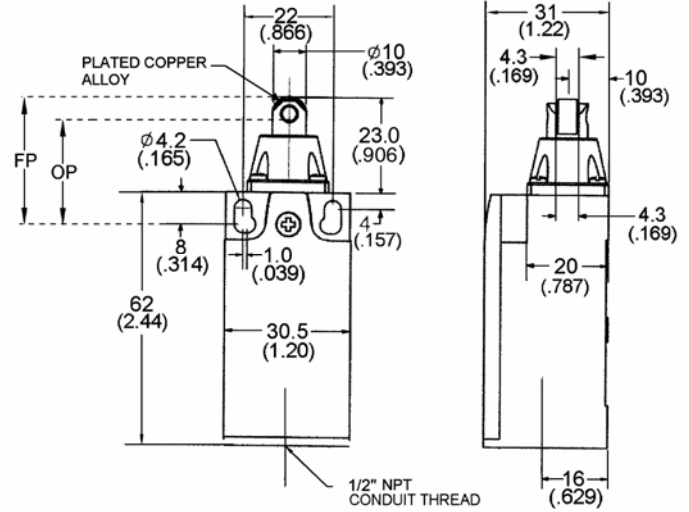

**GLLA01A1B, GLLC01A1B**

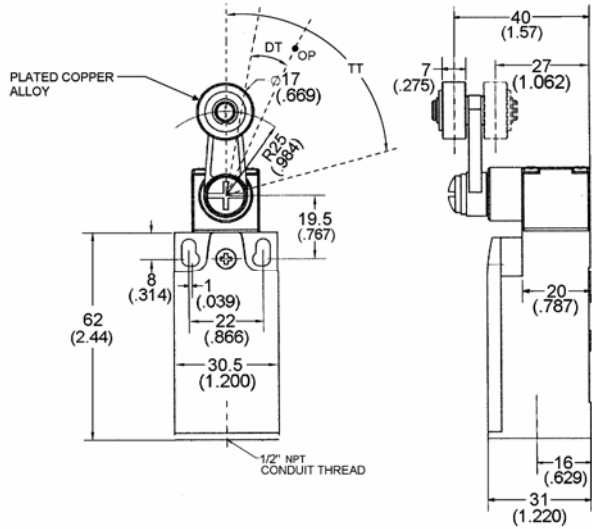

**GLLA01A2B, GLLC01A2B**

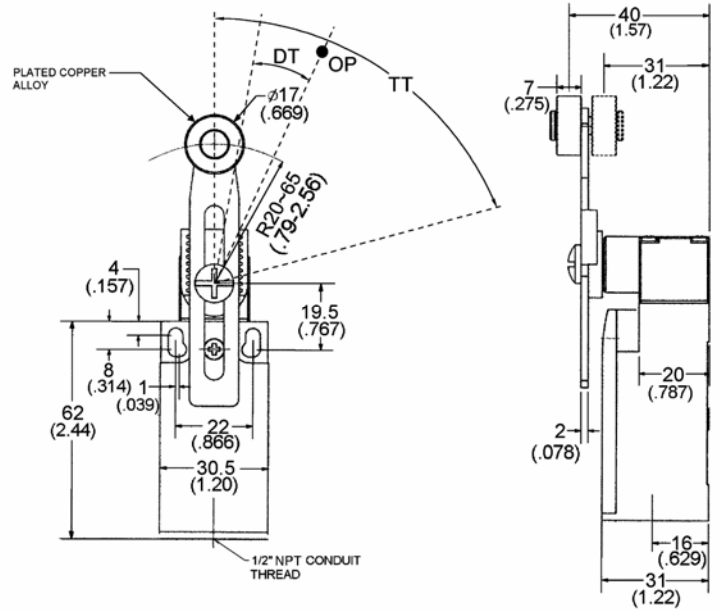

# Limit Switches

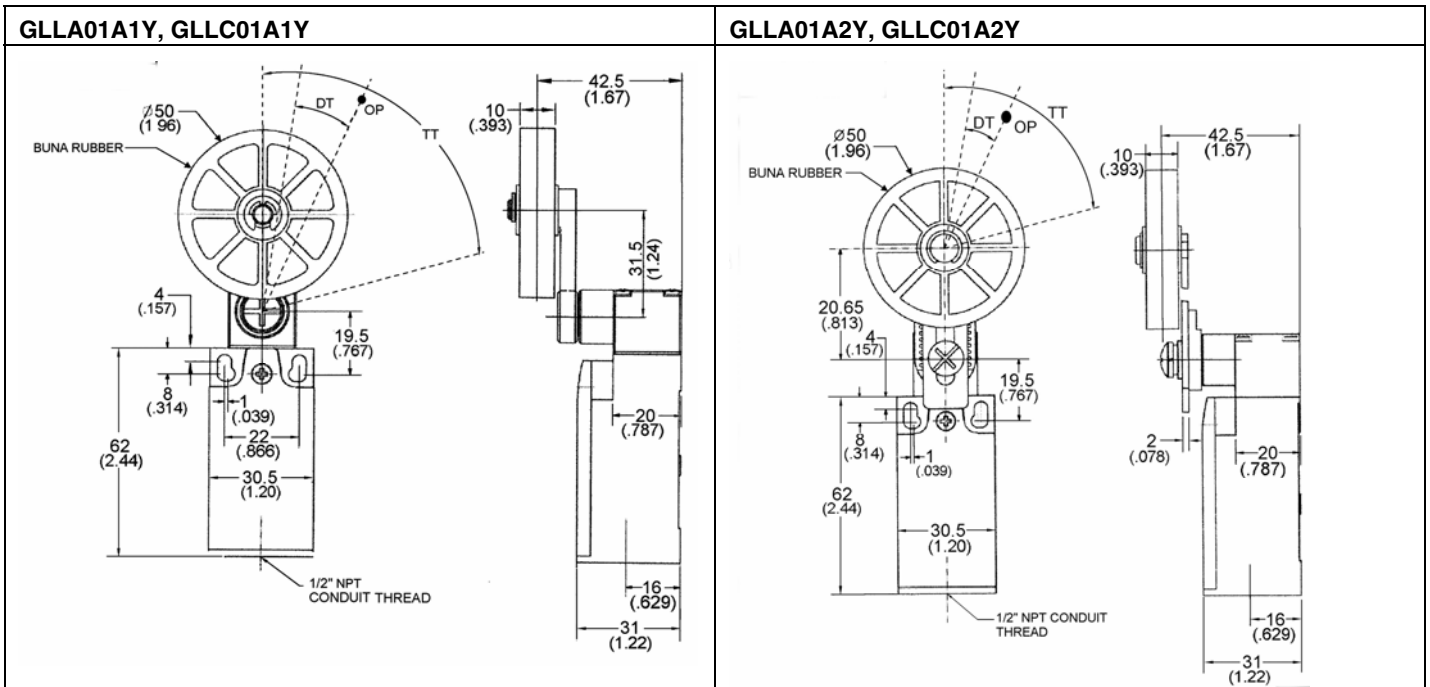

## GLL MIN-DIN (EN50047) PLASTIC

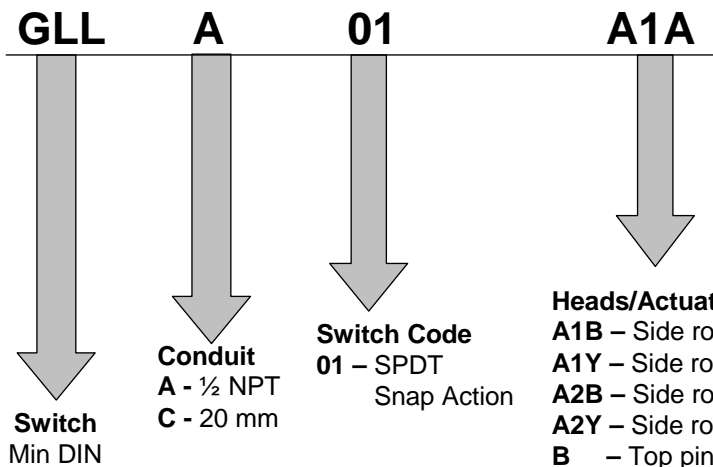

## ORDER GUIDE

<b>GLLA01B</b>	1/2" NPT conduit, top plunger
<b>GLLC01B</b>	20 mm conduit, top plunger
<b>GLLA01C</b>	1/2" NPT conduit, top roller plunger
<b>GLLC01C</b>	20 mm conduit, top roller plunger
<b>GLLA01A1B</b>	1/2" NPT conduit, side rotary – 25 mm fixed length with metal roller
<b>GLLC01A1B</b>	20 mm conduit, side rotary – 25 mm fixed length with metal roller
<b>GLLA01A2B</b>	1/2" NPT conduit, side rotary – 20 mm to 65 mm adjustable length lever with metal roller
<b>GLLC01A2B</b>	20 mm conduit, side rotary – 20 mm to 65 mm adjustable length lever with metal roller
<b>GLLA01A1Y</b>	1/2" NPT conduit, side rotary – 31,5 mm fixed length lever with 50 mm rubber roller
<b>GLLC01A1Y</b>	20 mm conduit, side rotary – 31,5 mm fixed length lever with 50 mm rubber roller
<b>GLLA01A2Y</b>	1/2" NPT conduit, side rotary – 20 mm to 65 mm adjustable length lever with 50 mm rubber roller
<b>GLLC01A2Y</b>	20 mm conduit, side rotary – 20 mm to 65 mm adjustable length lever with 50 mm rubber roller

### **WARNING**

#### **IF USED IN APPLICATIONS CONCERNING HUMAN SAFETY**

- Only use NC direct opening (“positive opening”/“positive break”) contacts, identified by the symbol .
- Do NOT use flexible/adjustable actuators. Only use actuators designed for safety applications.
- Do NOT defeat, tamper, remove, or bypass this switch.
- Hazardous voltage, disconnect power before servicing.
- Strictly adhere to all installation and maintenance instructions.
- Consult with local safety agencies and their requirements when designing a machine-control link, interface and all control elements that affect safety.

**Failure to comply with these instructions could result in death or serious injury.**

#### **WARRANTY/REMEDY**

Honeywell warrants goods of its manufacture as being free of defective materials and faulty workmanship. Honeywell's standard product warranty applies unless agreed to otherwise by Honeywell in writing; please refer to your order acknowledgement or consult your local sales office for specific warranty details. If warranted goods are returned to Honeywell during the period of coverage, Honeywell will repair or replace, at its option, without charge those items it finds defective. **The foregoing is buyer's sole remedy and is in lieu of all other warranties, expressed or implied, including those of merchantability and fitness for a particular purpose. In no event shall Honeywell be liable for consequential, special, or indirect damages.**

While we provide application assistance personally, through our literature and the Honeywell web site, it is up to the customer to determine the suitability of the product in the application.

#### **Automation and Control Solutions**

Sensing and Control

Honeywell

1985 Douglas Drive North

Golden Valley, Minnesota 55422

[www.honeywell.com/sensing](http://www.honeywell.com/sensing)

### **WARNING**

#### **MISUSE OF DOCUMENTATION**

- The information presented in this product sheet is for reference only. Do not use this document as a product installation guide.
- Complete installation, operation, and maintenance information is provided in the instructions supplied with each product.

**Failure to comply with these instructions could result in death or serious injury.**

Specifications may change without notice. The information we supply is believed to be accurate and reliable as of this printing. However, we assume no responsibility for its use.

#### **SALES AND SERVICE**

Honeywell serves its customers through a worldwide network of sales offices, representatives and distributors. For application assistance, current specifications, pricing or name of the nearest Authorized Distributor, contact your local sales office or:

**E-mail:** [info.sc@honeywell.com](mailto:info.sc@honeywell.com)

**Internet:** [www.honeywell.com/sensing](http://www.honeywell.com/sensing)

#### **Phone and Fax:**

Asia Pacific	+65 6355-2828
	+65 6445-3033 Fax
Europe	+44 (0) 1698 481481
	+44 (0) 1698 481676 Fax
Latin America	+1-305-805-8188
	+1-305-883-8257 Fax
USA/Canada	+1-800-537-6945
	+1-815-235-6847
	+1-815-235-6545 Fax

# Honeywell